



**Trusted Australian Brand. World's Best Quality!**

All prices include GST

Hurry! Offer valid while stocks last and finish on 30/06/2024!

### No.205 3Pc. Extra Long Spark Plug Boot Removal Pliers

Extra long length for those hard to reach areas. Ideal for spark plug wire removal, vacuum hose removal, wire removal and any metal tubing removal. Red cushioned grips for easy visibility and comfort.

Was:\$162 **NOW: \$129**

**New**



### No.985 8" Flat Band Hose Clamp Pliers

Hose Clamp pliers make installing and removing flat-typed hose clamps in hidden and hard to reach areas easier. Ideal for most ring-type and flat-band hose clamps. Special jaw design grips hose clamps in any position. Cr-Mo Steel forged.



**New**

Was:\$62  
**NOW: \$49**

### No.3221 12Pc. Noid Lights / IAC Test Lights & Ignition Set

Testing a variety of injection, spark plug circuit and Idle Air Control valves. includes an extension lead to test from the drivers seat.

Was:\$101

**NOW: \$79**

**New**



### No.LY03C-6D New Ratcheting Terminal Crimp Plier Set

**New**

Was:\$248

**NOW: \$198**



### No.B1102 European Truck Ball Joint Remover (39mm)

This is the best tool for removing truck ball joints without damage to the ball joint and related parts.

Was:\$316

**NOW: \$253**

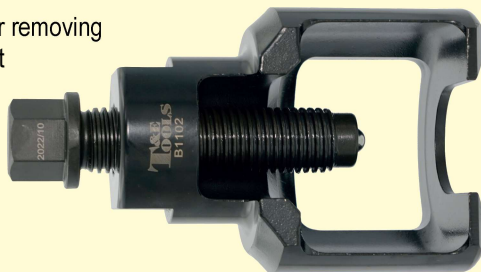

### No.8406 6Pc. Pin Punch Set

**Material:** Chrome Molybdenum  
Made to DIN standard 6450

**Sizes:** 3mm, 4mm, 5mm, 6mm, 8mm & 10mm.

**Length:** 150mm

In metal storage case

Was:\$73

**NOW: \$58**



### No.8410 10Pc. Pin Punch & Chisel Set

**Sizes:** 2 x 115mm long,

3 x 125mm long,

4 x 150mm long,

5 x 165mm long,

6 x 180mm long,

8 x 180mm long,

10 x 180mm long,

12 x 150mm long,

20 x 200mm long,

24 x 200mm long.

Was:

**\$118**

**NOW:**

**\$94**

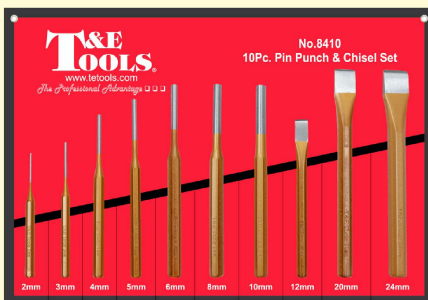

### No.J2605

### 5Pc. Brass Pin Punch

**Material:** Brass

**Sizes:** 6mm, 10mm, 12mm, 16mm & 19mm.

**Length:** 145mm

Was:\$122

**NOW: \$98**



### No.8019A Automatic Center Punch

No hammering required, just simply adjust tension screw to desired pressure, apply hand force and "pop" it's done. S2 Steel Tip. Features adjustable tension.

**Point Diameter:** 6mm.

**Length:** 155mm



Was:\$47 **NOW: \$38**

### No.CW404-MB MS17 Wheel Lug x 1/2"Dr Skt 85L for Mercedes Benz with Sleeve

Special 17mm (MS17) "flower style" socket to suit Mercedes Benz.



Was:\$24

**NOW: \$19**

**No.2059 Brake Caliper Press Spreader**  
 Works on twin and quad piston calipers. Works on single and twin piston floating calipers. Centrally located ratchet evenly spreads force in a parallel manner to prevent misalignment of pistons.



**Was: \$87**  
**NOW: \$69**

**No.2330 Four-In-One Brake Hone Kit**  
 Has all the parts necessary to assemble four individual hones. Quick release clips for easy removal and attachment of the 220 grit stones.



**Was: \$93**  
**NOW: \$74**

**No.2371 27 Piece Disc Brake Caliper Wind Back Kit**  
 Most comprehensive disc brake caliper wind back kit with 22 interchangeable heads. Some heads are double sided and both left and right hand piston retracting tools are included. Universal applications.



**Was: \$384**  
**NOW: \$307**

**No.2600 Truck & Tractor Brake Rivetter**  
 You are now able to hold the brake shoe and lining in one hand and fasten the rivet using a hammer in the other hand.

**Set Contains:**  
 Roll Punch 8 & 11mm  
 Star Punch  
 2 anvils with Hex Key



**Was: \$289**  
**NOW: \$229**

**No.WH505H Hand Pump Pressure Brake Bleeder**  
 Portable self contained hand pump will pressure bleed both standard and ABS brake systems. Features pressure relief cap, system gauge and quick release coupler.

**Capacity:** 1 gallon (3.5 Litres)



**Was: \$176**  
**NOW: \$139**

**No.H2101 Quick-Pro Premium Hacksaw**  
 Professional industrial quality hacksaw with cushion grip handles. Quick changing of blade to both 45° or 90°



**Was: \$107**  
**NOW: \$86**  
**Overall Length: 16.1/2" (420mm).**

**No.KW9114 14 Piece Bi-Metal Hole Saw Kit**  
**Sizes:** 3/4"(19mm), 7/8"(22mm), 1"(25mm), 1.1/4"(32mm), 1.3/8"(35mm), 1.1/2"(38mm), 1.3/4"(44mm), 2"(51mm), 2.1/4"(57mm), 2.1/2"(64mm), 3"(76mm).

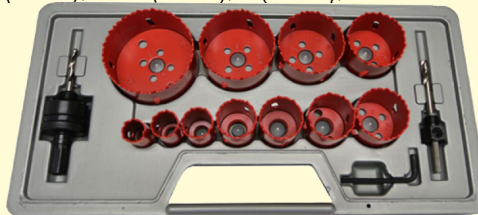

**Was: \$190**  
**NOW: \$152**

**No.3007 Long Probe Circuit Tester**  
 Extra long shaft 7" (180mm) for reaching into those hard to reach places.

**Length:** 12" (300mm).



**Was: \$42**  
**NOW: \$34**

**No.3011 12-24V DC Power-Up Auto Circuit Tester**  
**Voltage Range:** 0 – 70V DC  
**DC Current range:** 0 – 5A  
**Frequency Range:** 0-100K Hz  
**Resistance Range:** 0-200 KΩ  
**Cable length –** 2mtr



**Was: \$196**  
**NOW: \$157**

**No.3015 Digital LCD Circuit Tester**  
 Digital display to read the accurate voltage value. Use on 6, 12, 24 & 48 Volts DC system. LED indication for power (Red) and ground (Green). Voltage measurement from 4 to 60 Volts DC. Spring cable, which is able to extend to 3 meters. Small testing current < 10mA.



**Was: \$75**  
**NOW: \$59**

**No.P1959 Car Check Circuit Tester**  
 Ideal tester for checking voltage display for 6 Volt, 12 Volt, 24 Volt and 48 Volt on cars, trucks, buses and agricultural machinery. Complete with 3ft (900mm) lead wire, insulated spring ground clamp. LED Display Shows Polarity

**Length:** 7.3/4" (197mm).



**Was: \$23**  
**NOW: \$18**

**No.4220 Wrinkle Band Ring Compressor**  
 Cam lever operation requires just one setting adjustment for fast piston to piston change. Ideal for barrel cylinders which install over piston, as the band separates.

**Capacity:** 3" to 5" (75 to 125mm).  
**Depth:** 1.1/2" (38mm).



**Was: \$43**  
**NOW: \$34**

**No.4980**  
**Ring-O-Matic**  
**Piston Ring**  
**Compressor**  
*Capacity:* 2.7/8" to 4.3/8"  
 (73 to 111mm).  
**Was:**\$255  
**NOW:** \$204



**No.J1800 Universal Cam Shaft Bearing Tool**  
 The expander has a neoprene sleeve over which the split driving plugs are mounted and expanded to size. This tool has two sets of rubber sleeves supplied with it for each expanding driver.  
*Range:* 1.1/8" to 2.11/16" (28 to 68mm).  
**Was:**\$310  
**NOW:** \$248



**No.7210 Eccentric Cone**  
**Type SAE Flaring Set**  
 Eccentric design to flare tubing from 1/8 to 3/4". Hinge designed pipe holder for easy use & with a bearing locator on the side to centre the pipe and give a more accurate flaring.  
*Sizes:* 1/8", 3/16", 1/4", 5/16", 3/8", 1/2", 5/8" and 3/4".  
**Was:**\$267 **NOW:** \$214



**New**

**No.7211 Eccentric Cone**  
**Type Metric Flaring Set**  
 Eccentric design to flare tubing from 6 to 18mm. Hinge designed pipe holder for easy use & with a bearing locator on the side to centre the pipe and give a more accurate flaring.  
*Sizes:* 6mm, 8mm, 10mm, 12mm, 14mm, 15mm, 16mm and 18mm.  
**Was:**\$279 **NOW:** \$223



**New**

**No.7721 90° Precision Medium**  
**Tubing Bender**  
*Sizes:* 1/4", 5/16", 3/8" (6mm, 8mm, 10mm) Diameter Tube.  
*Length:* 8.1/2" (217mm).  
**Was:**\$66  
**NOW:** \$53



**No.7212 Brake Pipe Flaring Tool Set**  
 An easy to use flaring and double flaring tool suited for copper and stainless tubing. *Sizes:* 3/16", 1/4", 5/16" and 3/8" for copper, stainless steel pipe, steel forged yoke.  
**Was:**\$600  
**NOW:** \$479



**New**

**No.F1007 10Pc. Diamond**  
**Needle File Set**  
 Ten special shaped Diamond Needle Files with Titanium coating, two round, two half round, two flat tapered, one flat parallel, two triangle tapered, one square tapered, for cleaning, dressing and sharpening extra hard small parts etc.  
*Lengths:* 135mm.  
**Was:**\$45 **NOW:** \$36



**No.A480N 16oz. Grip**  
**Type Grease Gun**  
*Easy three-way loading:* Takes standard 16oz (450g) cartridge. Fill from pressure fed pump. Built in plunger suction. Manual fill or cartridge load.  
*Capacity:* 16oz (450gm).  
**Was:**\$83  
**NOW:** \$66



**No.6213 13 Piece SAE Long Arm**  
**Hex Key Set**  
*Set Contain Sizes:* 0.05", 1/16", 5/64", 3/32", 7/64", 1/8", 9/64", 5/32", 3/16", 7/32", 1/4", 5/16", 3/8".  
**Was:**\$37  
**NOW:** \$29



**No.6809 9 Piece Metric Ball End Hex-Key Set**  
*Contain Sizes:* 1.5mm, 2mm, 2.5mm, 3mm, 4mm, 5mm, 6mm, 8mm, 10mm.  
**Was:**\$41  
**NOW:** \$33



**No.J6675**  
**8 Piece Tamper Torx Long Arm Key Set**  
*Sizes:* T10, T15, T20, T25, T30, T40, T45, T50.  
**Was:**\$67  
**NOW:** \$54



**No.J6809**  
**8 Piece Long Arm Metric Ball End Hex-Key Set**  
*Contains Sizes:* 2mm, 2.5mm, 3mm, 4mm, 5mm, 6mm, 8mm, 10mm.  
**Was:**\$40  
**NOW:** \$32



**Digital Vernier Caliper with Fractional**

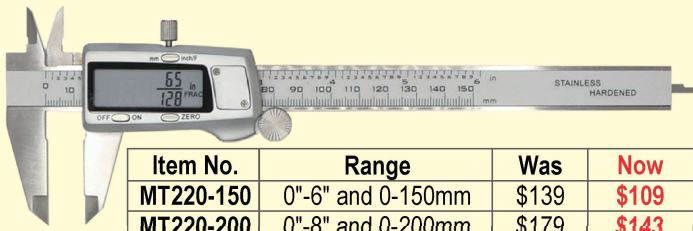

| Item No.  | Range               | Was   | Now          |
|-----------|---------------------|-------|--------------|
| MT220-150 | 0"-6" and 0-150mm   | \$139 | <b>\$109</b> |
| MT220-200 | 0"-8" and 0-200mm   | \$179 | <b>\$143</b> |
| MT220-300 | 0"-12" and 0-300mm. | \$229 | <b>\$183</b> |

**Digital Vernier Caliper Stainless Steel**



| Item No.  | Range               | Was   | Now          |
|-----------|---------------------|-------|--------------|
| MT028-150 | 0"-6" and 0-150mm   | \$112 | <b>\$89</b>  |
| MT028-200 | 0"-8" and 0-200mm   | \$160 | <b>\$128</b> |
| MT028-300 | 0"-12" and 0-300mm. | \$275 | <b>\$219</b> |

**No.4261 Toyota/Lexus Oil Filter Wrench  
64.5mm x 14 Flutes  
(inner:79.5mm)**

Suits Toyota 6 & 8 Cylinder Engines.  
14 Flutes x 64.5mm / Outer Dia. 90mm  
Cartridge style oil filter wrench



Was:\$37  
**NOW: \$29**

**No.4263 Toyota/Prius/Corolla Oil Filter Wrench  
64.5mm x 14 Flutes  
(inner:70mm)**

Suits Toyota 4 Cylinder Engines.  
14 Flutes x 64.5mm / Outer Dia. 79mm  
Cartridge style oil filter wrench



Was:\$37  
**NOW: \$29**

**No.4310 Extra Large Swivel Jaw Oil Filter Pliers**

Length: 15.3/4" (400mm).  
Capacity: 3.1/8" to 7.1/2"  
(80 to 190mm).



Was:\$186  
**NOW: \$149**

**No.4305 18" Adjustable Oil Filter Pliers**



Length: 18"(450mm).  
Capacity: 3.1/4" to 7"(95mm to 180mm).

Was:\$109  
**NOW: \$87**

**No.C2156 Oil Filter Cutter (60mm to 140mm)**

Length: 11" (280mm).  
Capacity:  
2.3/8" to 5.3/8"  
(60mm to 140mm).



Was:\$182  
**NOW: \$146**

**No.6932 32oz. Rubber Tyre Mallet**



Diameter: 3" (75mm).  
Face Diameter: 2.3/4" (70mm).  
Weight: 32oz (905gm).  
Length: 17" (430mm).

Was:\$34  
**NOW: \$27**

**Multi-Purpose Fluid Syringe**

Multipurpose syringe with Viton® seal, for removing or replacing oil from Transmissions, Engines, Gearboxes, Differentials, Master Brake Cylinders, etc. The syringe body is transparent with a measuring scale.

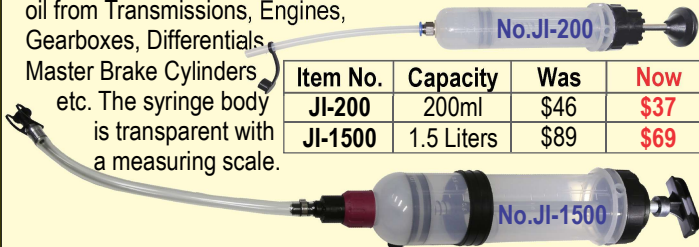

| Item No. | Capacity   | Was  | Now         |
|----------|------------|------|-------------|
| JI-200   | 200ml      | \$46 | <b>\$37</b> |
| JI-1500  | 1.5 Liters | \$89 | <b>\$69</b> |

**Stainless Steel Oil Filter Wrenches**

Dimples on band give a positive grip. New extra large comfort grip handle with 200° swivel joint. Unique stainless steel band design will not crush filters.



| Part No. | Capacity   | Was  | Now         |
|----------|------------|------|-------------|
| SS4252   | 60 x 76mm  | \$50 | <b>\$39</b> |
| SS4251   | 73 x 85mm  | \$44 | <b>\$34</b> |
| SS4253   | 85 x 99mm  | \$53 | <b>\$42</b> |
| SS4255   | 95 x 111mm | \$53 | <b>\$42</b> |

**No.1030 4 Piece Utility Wedge Set**

The four tough nylon wedges are particularly suitable for body work such as removing and installing trim strips, door trims, door clips etc.



Was:\$64  
**NOW: \$49**

**No.1115 Windscreen Removal Tool Set**

Contains necessary tools for the safe removal of windscreens  
Was:\$269

**NOW: \$214**



**No.7047 Panel Beaters Club Hammer (3 lbs)**

Drop forged, hardened and tempered. Rust resistant black baked enamel finish on sides with polished faces and beveled edges.  
High grade 1078 steel with American Hickory handle.  
**Head Weight:** 3lb(1.4kg) **Length:** 10.1/2" (270mm)



Was:\$49 **NOW: \$39**

**No.127 12Pc.Quick Change Internal / External Circlip Plier Set**

Three different tip angles: Straight, 45° and 90°.  
Four different tip sizes: .038", .047", .070", .090".

Was:\$323  
**NOW: \$259**



**No.129 Extra Heavy Duty Internal & External Circlip Plier Set**

**Length:** 16" (400mm).  
**Spread:** 3.3/8" (85mm).

Was:\$273  
**NOW: \$218**



**No.415 16" H/Duty Rib-Lock Multigrip Pliers**

Jaws are milled with deep, sharp self gripping teeth.  
**Maximum Parallel Opening:** 4.1/4" (110mm).  
**Length:** 16" (400mm).

**CR-MO Steel**

Was:\$183  
**NOW: \$147**



**No.984 Toyota & Lexus Hose Clamp Tool**

Hose Clamp Tool has a two screw design. One for removal of the clamp and one for fixing it in position.

Was:\$103  
**NOW: \$83**



**No.4791 27 Piece Professional Cutting & Scraping Set**

**Blade Sizes:** 12, 16, 20mm Straight and 16mm at a 53° angle.  
Plus 5 trimming knife blades with dispenser.

Was:\$55  
**NOW: \$44**



**No.5945 12Pc. Plier Organizer Rack**

Maximize your storage by organizing pliers upright in toolbox drawers etc.

Was:\$51  
**NOW: \$39**

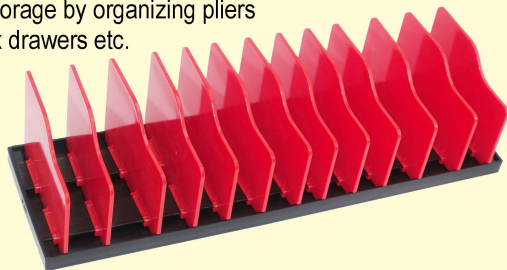

**No.5993 24" 20Lb. per Inch Magnetic Tool Bar**

Extra heavy-duty bar type magnetic tool holder that holds up to 20 pounds per inch. Supplied with fixing brackets, bolts and screws.  
**Length:** 24" (610mm).

Was:\$109 **NOW: \$79**



**No.8904 Small Hose Cutter**

Hose cutter is used to get a straight clean leak free cut on all soft hose connections.  
**Max Capacity:** 5/8"(16mm)

Was:\$28  
**NOW: \$22**



**No.GLFH9 Multi-Purpose Locking Pliers**

Can be used as an adjustable wrench, wire crimper, locking vice, wire cutter, hammer head, nail/pin puller, sure grip clamp or long nose pliers.  
**Length:** 9" (230mm).

**CR-MO Steel Jaws**

Was:\$49  
**NOW: \$39**



**No.PT1130 8" Long Nose Pliers**

Heavy duty long nose pliers with built in side cutting feature. Cushion grip handles. Made from drop forged alloy steel. Induction hardened serrated jaws.  
**Length:** 8"(200mm).

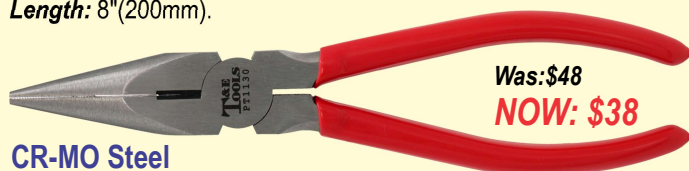

Was:\$48  
**NOW: \$38**

**CR-MO Steel**

**No.PT1138 8" Long Nose Spring Joint Pliers**

High quality long nose pliers feature a built in spring within the plier joint. Induction hardened jaws. Forged chrome alloy steel polish finish with insulated handles.  
**Length:** 8" (200mm).



Was:\$63  
**NOW: \$49**

**CR-MO Steel**

**No.WC712 Multi Strand Cable Cutter**

Features compound action with spring opening. Parrot beak jaws. Designed for clean cutting of multi-strand cable and wire.  
**Capacity:** 1/4" (6mm). **Length:** 7.1/2" (190mm).



Was:\$39 **NOW: \$29**

**No.8760 4Pc Comfort-Grip Pry Bar Set**

Features high quality forged heat treated chrome molybdenum steel blades fitted with extra large Comfort-Grip tang-thru handles. Ideal for prying cylinder heads, manifolds, transmission cases and drive line components.  
 Supplied in tough canvas vinyl wallet.  
**Was:\$136**



**NOW: \$109**

**No.8712-R 12" Roll Head Pry Bar**

Forged from chrome alloy steel and heat treated to resist bending or breaking. Roll head makes a great deal of leverage possible. Long tapered body can be used as a lining-up drift.

**Length:** 12" (300mm).  
**Stock:** 1/2" (13mm) Hex Hex.  
**Blade Width:** 5/8" (16mm).

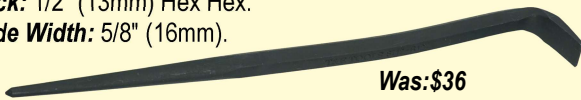

Was:\$36  
**NOW: \$29**

**No.8715-R 15" Roll Head Pry Bar**

Forged from chrome alloy steel and heat treated to resist bending or breaking. Roll head makes a great deal of leverage possible. Long tapered body can be used as a lining-up drift.

**Length:** 15" (380mm).  
**Stock:** 1/2" (13mm) Hex.  
**Blade Width:** 11/16" (17mm).



Was:\$43  
**NOW: \$34**

**No.8731B 3 Piece 16", 24" & 30" Jimmy Bars**

16"(400mm) **Stock:** 5/8"(16mm) Hex, **Blade Width:** 1"(24.5mm)

24"(600mm) **Stock:** 3/4"(19mm) Hex, **Blade Width:** 1"(33mm)

30"(760mm) **Stock:** 7/8"(19mm) Hex, **Blade Width:** 1.1/4"(33 mm)

Was:\$129 **NOW: \$103**

**No.8988 25 Piece Multi-Spline Extractor Set**

**Sizes:** 1/8" to 7/8" in 1/32" Increments (3mm to 22mm in 0.8mm).

**All Extractor Lengths:** 1.3/8" (35mm).

Was:\$333  
**NOW: \$266**



**No.8960 9 Piece Square Type Screw Extractor Set**

Sharp undercut edges provide a solid grip on broken studs, set screws pipe & Alemite fittings.  
**Was:\$269**

**NOW: \$214**



**No.9009 10 Piece Bearing Race & Seal Driver Set**

**Adaptor Sizes:** 40mm, 44mm, 50mm, 60mm, 63mm, 65mm, 70mm, 75mm, 80mm (1.9/16" to 3.3/16").

**Driver Handle:** 5.1/2" x 1" (140mm x 25mm).

Was:\$218 **NOW: \$174**



**No.9012 50Pc.Custom Bush / Seal / Bearing Driver Set**

This master set allows you to build your own custom bushing driver. Select the required sizes and assemble your driver tool. Discs are 18mm through to 65mm in 1mm increments.

Was:\$645  
**NOW: \$516**



**No.B1299 Mercedes Benz CDI Injector Puller Set**

**Applicable:** Mercedes CDI engines 611,612, 613,646,647,648 etc diesel engines.

Was:\$259  
**NOW: \$207**



**No.BP1238 3 Jaw Pilot Bearing Puller**

Powerful extra slim 3 jaw bridge pattern internal puller will remove almost all automotive flywheel pilot bearings.

**Capacity:** 1/2" to 1.1/2" (13 to 38mm)  
**Length:** 8.1/4" (210mm)

Was:\$143  
**NOW: \$114**

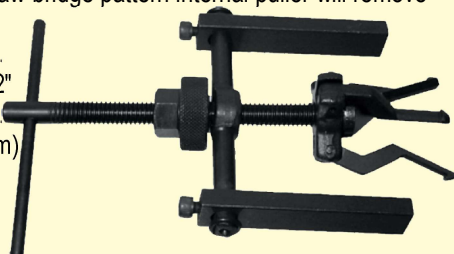

**No.J7260 Master Universal Ball Joint Service Kit**

Includes 18 separate adaptors to fit most ball joints fitted to early and late model vehicles.

**Forged Webbing C-Clamp Size:** 10" (255mm).

Was:\$462  
**NOW: \$369**



**No.J7928A 12Pc. Universal Tie Rod Removal Set**

**Sizes:** 14mm, 17mm, 19mm, 22mm, 26mm, 27mm, 33.6mm, 1.3/16", 1.1/4", 1.5/16" & 1.7/16" to engage on the nut flats.

**Was:\$204**  
**NOW: \$163**



**No.YC9005 3"(75mm) Bearing Splitter**

**Capacity:** 2" to 3"(50mm to 75mm)  
**Tapped Holes:** 3/8" x 16tpi UNC  
**Bolt Length:** 135mm  
**Distance Between Bolts:** 90mm (SCM415 Hardened 42-45HRC)  
**Was:\$61**

**NOW: \$49**

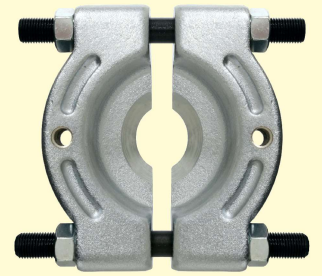

**No.8296 5Pc. Air Hammer Chisel Set**

**Includes:**  
Point chisel.  
Sheet metal trimmer.  
Single cut panel cutter chisel.  
Spot weld breaker chisel.  
Flat chisel.

**Was:\$122**  
**NOW: \$98**



**No.8369 100mm Seam Edge Bolster**

Bolster is drop forged with ground taper seaming edge. The protective cover holder has a flange diameter to give full protection from miss directed hammer blows.

**Width:** 4" (100mm).  
**Length:** 10" (255mm).

**Was:\$55** **NOW: \$44**



**No.8418 17 Piece Punch & Chisel Set**

**Set**  
Drift Punches: 2mm, 3mm, 4mm, 5mm, 6mm.  
Centre Punches: 3mm, 4mm Point.  
Cold Chisels: 12mm, 18mm.  
Cape Chisels: 5mm, 7mm.  
Pin Punches: 2, 3, 4, 5, 6 and 8mm.

**Was:\$182**  
**NOW: \$146**



**No.8420 20 Piece Punch & Chisel Set**

**Includes:** Pin punches, Centre punch, Prick punch, Drift punches, Long taper punches, Cold chisels, Diamond point chisel, Cape chisel, Round nose chisel, Extra long chisel.

**Was:\$245** **NOW: \$196**

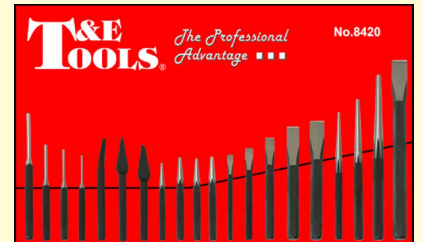

**No.8936 2 Piece Brass Taper & Straight Punch Set**

Brass Taper Drift Punch: 3/8" (10mm) point, 3/4" (19mm) stock, 8" (200mm) long.  
Brass Straight Drift Punch: 3/4" (19mm) point, 3/4" (19mm) stock, 10" (250mm) long.

**Was:\$205**  
**NOW: \$164**



**No.7516SET 4Pc. Gasket Scraper Set "Pro"**

**Blades Sizes:**  
16mm and 25mm x 200mm Long,  
13mm and 25mm x 310mm Long.

**Was:\$156**  
**NOW: \$124**



**No.J7555 5Pc. Gasket Scraper & Hook Set**

Use for scraping surfaces before installing new gaskets. The short chisel & three various point end picks makes it easy getting into confined spaces.

**Was:\$56**  
**NOW: \$44**



**No.J8413 13Pc. Interchange Punch & Chisel Set**

**Set Includes:** Centre Punch Sizes: 3mm, 5mm Point. Cold Chisel Sizes: 13mm, 16mm, 19mm, 22mm, 25mm. Cape Chisel Sizes: 6mm. Pin Punch Sizes: 5mm, 6mm. Tapered Drift Punch Sizes: 3mm, 6mm. Safety Protective Handle: 8" (200mm) Long.

**Was:\$107** **NOW: \$86**



**No.J8910 10 Piece Roll Pin Punch Set**

Each punch has a precision machined, specially shaped tip for the removal & replacement of press fit roll pins.

**Sizes:** 2mm, 3mm, 4mm, 5mm, 5.5mm, 6mm, 8mm, 10mm, 11mm, 13mm.  
**Was:\$109** **NOW: \$87**



**No.5711 15Pc. Oil Drain Plug Socket Set**

**Sizes(mm):** 8,9,9.5,10,12, 14,17 Hex 8(5/16"), 9.5Sq., 11Sq., 12Sq., 13Sq. 10 Female Sq. 3/8" Triangle.  
**Suits:** BMW, Ford, GM, Nissan, Peugeot, Honda, VW, Volvo, Toyota, Mazda etc.

**Was:\$124** **NOW: \$99**



**No.TD40BS 40Pc. SAE Tap & Die with Gear Ratchet Wrench Brake Caliper Press Spreader**

**Set Includes:** Taps & Dies: 4NC40, 6NC32, 8NC32, 10NC24, 10NF32, 12NC24, 1/4NC20, 1/4NF28, 5/16NC18, 5/16NF24, 3/8NC16, 3/8NF24, 7/16NC14, 7/16NF20, 1/2NC13, 1/2NF20, 1/8NPT27; 1Pc. Gear Wrench; 2Pc. Tap Holder (M3-M6)(M6-M12); 1Pc. Die Stock; 1Pc. Screw Driver; 1Pc. Screw Pitch gauge.

**Was:\$192 NOW: \$154**



**No.T40M 40Pc. Metric Tap & Die Set**

**Taps & Dies:** 3 x 0.5mm, 5 x 0.8mm, 7 x 0.75mm, 10 x 1.25mm, 1/8" x 27NPT, 3 x 0.6mm, 5 x 0.9mm, 7 x 1.0mm, 10 x 1.5mm, 4 x 0.7mm, 6 x 0.75mm, 8 x 1.0mm, 12 x 1.5mm, 4 x 0.75mm, 6 x 1.0mm, 8 x 1.25mm, 12 x 1.75mm

**Was:\$174**

**NOW: \$139**



**No.S78016 16Pc. Tang Thru Screwdriver Set**

**S2 Steel Shafts Set Contains:**

Phillips Stubby: #1, #2, Phillips #0, #1, #2, #3, #4. Slotted Stubby: 6.3mm, Slotted: 3.2mm, 4mm, 5mm, 5mm, 6mm, 6mm, 8mm, 9.5mm.

**Was:\$216**

**NOW: \$173**



**No.5600 10 Piece E-Series Female Torx-r Sockets**

**Was:\$57**

**Contains (Supplied On Socket Rail):**

**NOW: \$46**

**1/4" Drive Sizes:** E4, E5, E6, E7, E8 23mm Long.

**3/8" Drive Sizes:** E10, E12, E14, E16, E18 28mm Long.



**No.A5146 7Pc. Acetate Torx-r Screwdriver Set**

**Set Contains:**

Torx: T10, T15, T20, T25, T27, T30, T40.

**Was:\$58**

**NOW: \$46**



**No.5944 Socket Rack Tray**

**Metal tray includes:** 20 x 1/4" Drive, 30 x 3/8" Drive, 30 x 1/2" Drive Clips and 4 x 17" Socket Rails.

**Tray Size:** 6" x 18" (150 x 450mm).

**Was:\$67**

**NOW: \$54**



**No.93916 16Pc. SAE Flare Nut Crowfoot Wrench Set**

**3/8"Dr. Sizes:** 5/16" to 3/4", **1/2"Dr. Sizes:** 13/16" to 1.1/4".

**Was:\$179 NOW: \$143**



**No.93919 19Pc. Metric Flare Nut Crowfoot Wrench Set**

**3/8" Drive:** 8 to 19mm. **1/2" Drive:** 21, 22, 24, 27, 28, 30 & 32mm.

**Was:\$199 NOW: \$159**

**No.21534 3Pc. Super Fine Extra Long Handle Ratchet Set**

**Contains:** 1/4"Dr.: #22534 Length: 228mm

3/8"Dr.: #23534 Length: 406mm 1/2"Dr.: #24534 Length: 559mm



**Was:\$310 NOW: \$248**

**New 108 Teeth**

**No.21531 3Pc. Super Fine Stubby Ratchet Set**

**New 108 Teeth**

Extra fine ratchet action with 108 Gear teeth ratchet swing arc of 3.3° allowing faster work in the most confined of spaces. Sealed head with Forward and Reverse drive and manufactured from Chrome Vanadium.

**Was:\$150**

**NOW: \$119**

**Contains:**

1/4"Dr.: #22531

3/8"Dr.: #23531

1/2"Dr.: #24531



**No.21580 3 Piece Extra Long Ratchet Set**

**Contains:** 1/4"Dr. #22580 Length: 11.1/4"(285mm)

3/8"Dr. #23580 Length: 17.3/4"(450mm)

1/2"Dr. #24580 Length: 24.3/4"(630mm)



**Was:\$352 NOW: \$282**

**No.23800 3/8" Drive 72 Tooth Ratchet Adaptor**

**Length:** 2" (50mm).

**Was:\$55 NOW: \$44**



**No.24800 1/2" Drive 72 Tooth Ratchet Adaptor**

**Length:** 2.1/4" (60mm).

**Was:\$57 NOW: \$46**

**No.24615 1/2"Drive x 15" Adjustable Handle**

**Length:** 15" (380mm).

**Was:\$59 NOW: \$47**

**No.24FH 1/2"Drive x 24" Adjustable Handle**

**Length:** 24" (610mm).

**Was:\$105 NOW: \$84**





**No.AWK135N 135Nm x 3/8" Drive Digital Angle Torque Wrench**

**Torque & Angle:** 6.8 to 135 Nm, 5 to 99 Ft/Lb, 60 to 1195 In/Lb.  
**Measured Range:** 69 to 1378 Kg/Cm, 0° to 30°.  
**Resolution:** 0.1Nm, 1in/lb, 0.1ft/lb, 1kg/cm, 1°Angle.



Was:\$722 **NOW: \$578**

**No.25555 6Pc. 3/4"Dr. Ratchet, Flex Head & T-Bar Set**

3/4" Dr. Handle extends from 20" to 36" (510 to 915mm) 40 tooth Ratchet Head, Flex-Head and T-Bar all interchange with extendable handle.

Was:\$612  
**NOW: \$489**



**No.62030 6-30Nm x 1/4"Dr. Clicker Torque Wrench**

**Size:** 1/4" Drive. **Increments:** 0.2Nm (0.148Ft/lb)  
**Length:** 300mm. **Range:** 6 to 30Nm (4.4 - 22.4Ft/lb)



Was:\$190 **NOW: \$152**

**No.76345 8Pc. Impact Socket Adaptor Set**

1/4"Dr. F x 3/8"Dr. M  
 3/8"Dr. F x 1/4"Dr. M  
 3/8"Dr. F x 1/2"Dr. M  
 1/2"Dr. F x 3/8"Dr. M  
 1/2"Dr. F x 3/4"Dr. M  
 3/4"Dr. F x 1/2"Dr. M  
 3/4"Dr. F x 1"Dr. M  
 1"Dr. F x 3/4"Dr. M



Was:\$187 **NOW: \$147**

**No.5073 1000Ft/lb(1360Nm) Torque Multiplier**

Torque multipliers provide the necessary power to tighten threaded fasteners to exact torque requirements far beyond the range of your torque wrench. 1/2" Drive Input x 3/4" Drive Output. Supplied with a reaction bar.



Was:\$562  
**NOW: \$449**

**Ratio: 3 to 1**

**No.93227 9Pc. SAE 3/8"Dr. Torque Adaptor Set**

Set Contains: 1/4", 5/16", 3/8", 7/16", 1/2", 9/16", 5/8", 11/16", 3/4" Torque Adaptors 3/8"Dr.x50mm Centres.

Was:\$235 **NOW: \$188**

**No.93222 12Pc. Metric 3/8"Dr. Torque Adaptor Set**

Set Contains: 6-15mm, 17mm, 19mm Torque Adaptors 3/8"Dr. x 50mm Centres.

Was:\$353 **NOW: \$279**



**No.97274 74Pc. 1/4" Drive Standard & Deep Universal Impact Socket Set (6 Point)**

**Sizes:** 3/16" to 9/16".  
 4 to 15mm  
 Torx: T10 to T30  
 Was:\$477  
**NOW: \$379**



**No.92674 73 Piece 1/4"Drive SAE & Metric Socket Set (6 Point)**

**Sizes:** 5/32" to 1/2".  
 4 to 13mm  
**Incl. Hex Bits:**  
 Slotted, Philips, Torx,  
 In-Hex, Robinson  
 Was:\$245  
**NOW: \$194**



**No.93811 11 Piece 3/8" Drive Square Pipe Plug Sockets (Male & Female)**

**Contains:** 3/16", 1/4", 9/32", 5/16", 11/32", 3/8" Male Pipe Plug Sockets. 1/4", 9/32", 5/16", 11/32", 3/8" Female Pipe Plug Sockets.

Was:\$126 **NOW: \$99**



**No.93748 56 Piece 3/8" Drive SAE & Metric Socket Set (12 Point)**

**Sizes:** 1/4" to 7/8".  
 6 to 22mm.  
 Was:\$339  
**NOW: \$269**



**No.94221 20Pc.1/2"Dr. 6Pt. Std Metric Socket Set**

**Includes:**10-19mm, 21mm, 22mm, 24mm, 27mm, 30mm, 32mm.

Was:\$230 **NOW: \$184**

**No.94321 20Pc. 1/2"Dr. 12Pt. Std Metric Socket Set**

Was:\$229 **NOW: \$183**



**No.94639 36Pc. 1/2"Dr. 6Pt SAE/Metric Skt Set**

**Metric:** 10-19mm, 21mm, 22mm, 24mm, 27mm, 30mm, 32mm.

**SAE:** 3/8"-1.1/4".  
 3", 5", 10" Extensions.  
 Universal Joint.  
 Adjustable Handle.  
 Quick Release Ratchet.  
 Was:\$340  
**NOW: \$272**





**No.97414A 14Pc. 1/2"Dr. Standard 6Pt. SAE Impact Socket Set**

**Sizes:** 3/8", 7/16", 1/2", 9/16", 5/8", 11/16", 3/4", 13/16", 7/8", 15/16", 1", 1.1/16", 1.1/8", 1.1/4".

**Was:**\$130 **NOW:** \$99

**No.98414A 14Pc. 1/2"Dr. Standard 6Pt. Metric Impact Socket Set**

**Sizes:** 10mm, 11mm, 12mm, 13mm, 14mm, 15mm, 16mm, 17mm, 18mm, 19mm, 21mm, 22mm, 24mm, 27mm.

**Was:**\$127 **NOW:** \$98

**No.97448 8Pc. 1/2"Dr. SAE Impact Universal In-Hex Sockets**

**Sizes:** 1/4", 5/16", 3/8", 7/16", 1/2", 9/16", 5/8", 3/4" In-Hex Impact Universal Sockets 1/2" Drive x 75mm Long.

**Was:**\$239 **NOW:** \$189

**No.97449 8Pc. 1/2"Dr. Metric Impact Universal In-Hex Sockets**

**Sizes:** 6mm, 7mm, 8mm, 10mm, 12mm, 14mm, 17mm, 19mm In-Hex Impact Universal Sockets 1/2" Drive x 75mm Long.

**Was:**\$239

**NOW:** \$189



**No.95727 27Pc. 3/4"Dr. Master Socket**

**SAE Sockets 3/4" Dr.:** 7/8", 15/16", 1", 1.1/8", 1.3/16", 1.5/16", 1.3/8", 1.7/16", 1.5/8", 1.3/4", 1.7/8", 2". **Metric Sockets 3/4" Dr.:** 22, 24, 27, 30, 32, 36, 38, 41, 46, 50mm. **Extensions:** 4" & 8". 3/4" Drive **Heavy-Duty Ratchet:** Sliding T-Bar: 20".

**Was:**\$804

**NOW:** \$643



**Wobble Extension Set**

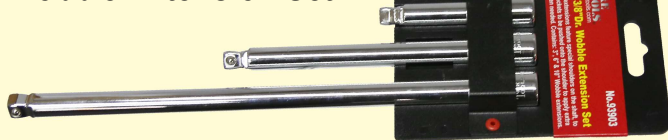

| Item No. | Drive   | Wobble Extension | Was  | Now  |
|----------|---------|------------------|------|------|
| 92903    | 1/4"Dr. | 2", 4", 6"       | \$34 | \$27 |
| 93903    | 3/8"Dr. | 3", 6", 10"      | \$46 | \$37 |
| 94903    | 1/2"Dr. | 3", 6", 10"      | \$61 | \$49 |

**No.S79209M 9Pc. 1/4"Dr. Stubby In-Hex Metric Impact Sockets 2.5-10mm**

**Length:** 1/4" Drive x 20mm Long.

**Sizes:** 2.5mm, 3mm, 4mm, 5mm, 6mm, 7mm, 8mm, 9mm, 10mm.

**Was:**\$65 **NOW:** \$52



**No.97414L 14Pc. 1/2"Dr. Deep SAE Impact Skt Set**

**Sizes:** 3/8", 7/16", 1/2", 9/16", 5/8", 11/16", 3/4", 13/16", 7/8", 15/16", 1", 1.1/16", 1.1/8", 1.1/4".

**Was:**\$164 **NOW:** \$129

**No.98414L 14Pc. 1/2"Dr. Deep Metric Impact Skt Set**

**Sizes:** 10mm, 12mm, 14mm, 15mm, 16mm, 17mm, 18mm, 19mm, 21mm, 22mm, 24mm, 27mm, 30mm, 32mm.

**Was:**\$178 **NOW:** \$139

**No.97515LA 15Pc. 3/4"Dr. SAE Deep Imp. Skt Set 3/4"-2"**

**Sizes:** 3/4", 7/8", 15/16", 1", 1.1/16", 1.1/8", 1.1/4", 1.5/16", 1.3/8", 1.7/16", 1.1/2", 1.5/8", 1.3/4", 1.7/8" 2" SAE 6 Point 3/4"Drive Deep Impact Sockets.

**Was:**\$792 **NOW:** \$634

**No.98515LA 15Pc. 3/4"Dr. Metric Deep Impact Skt Set 19-50mm**

**Sizes:** 19mm, 21mm, 22mm, 23mm, 24mm, 26mm, 27mm, 30mm, 32mm, 35mm, 36mm, 38mm, 41mm, 46mm, 50mm.

**Was:**\$710

**NOW:** \$568



**Magnetic (Ball Type) Spark Plug Socket**



| Item No. | Drive      | Maximum Opening | Was  | Now  |
|----------|------------|-----------------|------|------|
| 807314   | 3/8" Drive | 14mm 12 Point   | \$42 | \$34 |
| 807316   | 3/8" Drive | 5/8" 12 Point   | \$42 | \$34 |
| 807326   | 3/8" Drive | 13/16" 12 Point | \$42 | \$34 |

**No.S79309 9Pc.1/4"&3/8"Dr. SAE In-Hex Stubby Impact Skts 1/4"-3/4"**

**Sizes:** 1/4", 5/16", 3/8", 7/16", 1/4" Dive x 20mm Long. 1/2", 9/16", 5/8", 11/16", 3/8" Drive x 30mm Long. **Was:**\$63 **NOW:** \$49

**No.S79309M 9Pc.1/4" & 3/8"Dr. Metric In-Hex Stubby Impt Skts 6-19mm**

**Sizes:** 6mm, 7mm, 8mm, 10mm. 1/4" Drive x 20mm Long. 12mm, 14mm, 19mm. 3/8" Drive x 30mm Long.

**Was:**\$80

**NOW:** \$64



**No.S92909 9Pc. 1/4"Dr. Stubby Torx-r Impact Sockets**

**Length:** 1/4" Drive x 20mm Long. **Sizes:** T10, T15, T20, T25, T27, T30, T40, T45, T50.

**Was:**\$67 **NOW:** \$54



**No.T3202 32Pc. 1/2"Dr. Torx-r Bit Socket Set**

**Sizes:** T20, T25, T27, T30, T40, T45, T50, T55, T60, T70.

All bits are made from S2 Steel for extra strength.

**Lengths:** 55mm, 100mm, 140mm, 200mm Long

**Was:**\$249

**NOW:** \$199

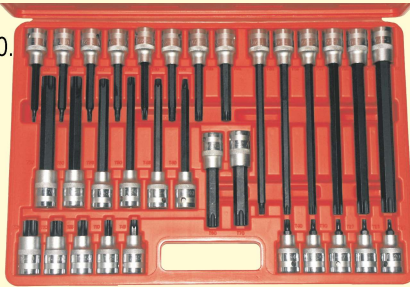

**No.T3203 32Pc. 1/2"Dr. Ribe Bit Socket Set**

**Sizes:** M5, M6, M7, M8, M9, M10, M12, M13, M14.

All bits are made from S2 Steel for extra strength.

**Lengths:** 55mm, 100mm, 140mm, 200mm Long

**Was:**\$332

**NOW:** \$264

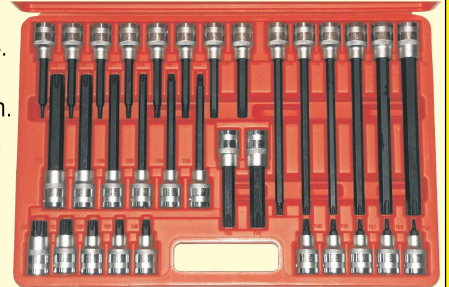

**No.T1000 100 Piece 1/4" Hex Insert S2 Steel Bit Set**

**Set Contains:** Phillips, Slotted, Pozidriv, Tri-Wing, Clutch Head, Spline, Torx, Tamper Torx, Square, Recess Square, Snake Eyes, In-Hex, Metric and SAE Tamper In-Hex Bits, Socket Bit Holder, Magnetic Bit Holder, Wing Nut Driver, 1" and 2" 1/4" Hex Extensions. **Was:**\$47 **NOW:** \$37



**No.8414 4 Piece Bearing Race Punch Set**

Forged oval shape striking ends of the punch allows the maximum contact with the race.

**Lengths:** 150mm(6"), 250mm(10"), 350mm(14") and 500mm(20").

**Was:**\$104

**NOW:** \$82



**No.4464 Universal Petrol & Diesel Engine Compression & Leakage Test Set**

**Was:**\$960

**NOW:** \$768



**No.4446 Two Gauge Master Fuel Injection Set**

3.1/2" Gauge with dual readings 0 to 145psi (0 to 1000kpa) plus a low pressure 2.1/2" gauge 0 to 15psi (0 to 1.0kg/cm2). The low pressure gauge enables accurate readings below 15psi.

**Was:**\$801 **NOW:** \$689

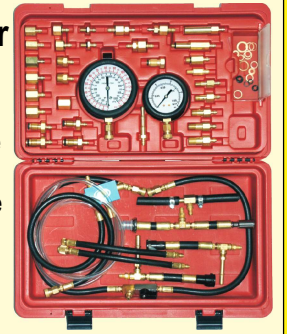

**No.4432 Engine Oil Pressure Tester**

**Range:** 0-100psi (0 to 7bar).  
**Gauge Diameter:** 2.1/2" (65mm).

**Was:**\$132

**NOW:** \$106



**No.7012 25 Blade Extra Long Feeler Gauge**

All Imperial Gauges are Permanently Etched On Each Blade with Metric Equivalents. Gauges are made from the finest grade steel and are hardened and tempered to withstand long wear. All gauges are equipped with knurled lock-nuts. **Contains:** Twenty five 12" x 1/2" (300 x 13mm) blades **Was:**\$78 **NOW:** \$62

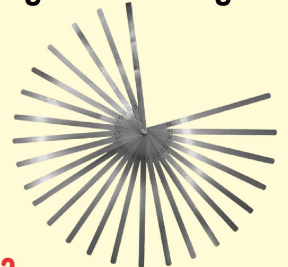

**No.7059 Dual Vacuum & Pressure Pump Tester**

**Gauge Diameter:** 2" (50mm).  
**Gauge Readings:** 0-30in Hg (0 to 76cm Hg) Vacuum. 0-60psi (0 to 1.4bar) Pressure.

**Was:**\$357

**NOW:** \$286



**No.4439N Exhaust Back Pressure Test Kit**

Quick and accurate checking for clogged catalytic converters, mufflers and exhaust systems.

**Gauge:** 60mm Diameter, 0 to 20psi (1.5 Bar).

**Was:**\$294

**NOW:** \$235

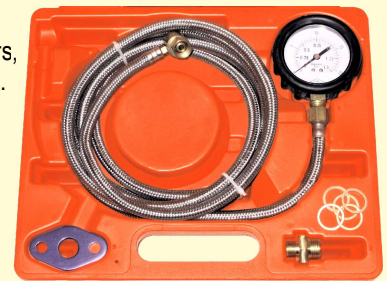

**No.6936 Digital Tyre Gauge**

Hi-Tech, solid-state, digital tyre gauge featuring push button operation, high impact case, in-built long-life lithium battery for long service.

**Was:**\$50

**NOW:** \$39



**No.1900 4WD Wheel Bearing Locknut Wrench (54mm)**

**Size:** 2.3/32" (54mm).  
**Length:** 3.1/2" (89mm).

**Was:**\$59

**NOW:** \$48



**No.GT3 Radiator Pressure Tester (Compact)**

**Contains:** Standard bayonet tank adaptor, 31 x 16mm & 32 x 10mm Asian adaptors, Radiator expanding adaptor and 3 rubber spacers, Hand pump and thermometer.

**Was:\$274**

**NOW: \$219**



**No.GT5 Universal Radiator Pressure Tester Set**

This new set is made from composite nylon material and offers the most comprehensive range of adaptors at an economical price.

**Was:\$358**

**NOW: \$286**



**No.MA230 Advance Timing Light**

For both conventional and electronic ignition systems. Adjustable advance with scale reading directly in degrees allows checking of basic ignition timing, vacuum advance, centrifugal advance, and computer advance.

**Was:\$223**

**NOW: \$178**



**No.RT-919F Truck Radiator Pressure Test Kit**

**Gauge Pressure:** 35 PSI.

**Gauge Diameter:** 1.7/8" (48mm).

**Was:\$296**

**NOW: \$237**



**No.RT-919J Radiator Cap Pressure Test Set**

**Size:** 31mm Dia. x 10mm Reach, 32mm Dia. x 16mm Reach, 1.5/8" Dia. x 3/4" Reach,

- 45 x 3mm Internal,
- 48 x 3mm Internal,
- 52 x 3mm Internal,
- 44 x 3mm Internal,
- 53 x 4mm Internal,
- 62 x 4mm Internal.

**Was:\$285 NOW: \$228**



**No.TT8004 GMH Ecotec Engine Timing Tool Set**

All the setting bars, locking pins and a two pin wrench that are required for setting the correct timing position when servicing GM Ecotec 2 litre engines.

**Was:\$100**

**NOW: \$79**



**No.TT8069 BMW/Land Rover/GM/Holden 1.8, 2.0, 2.5 Diesel Timing Tool Set**

Design for setting the timing position on the crankshaft and camshaft. Suitable for 1.8L, 2.0L & 2.5L chain driven diesel engines.

**Was:\$181**

**NOW: \$144**



**No.TT8164 Ford Diesel/Petrol Timing Tool Set**

This is an extensive set designed for a wide range of both diesel and petrol engines on Ford. It's suitable for some engines in Mazda, Land Rover, Suzuki & Volvo.

**Was:\$269**

**NOW: \$214**



**No.TT8322 BMW Vanos N51,N52,N52K,N53, N54,N55 Timing Locking Tool Set**

Kit covers N51/N52/N52K valve-tronic and N53/N54/N55 direct injection engines, and includes Vanos alignment plates for these engines.

**Was:\$799**

**NOW: \$639**

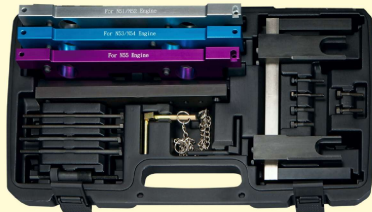

**No.TT8344 Holden Colorado / Chrysler / Jeep 2.8L Diesel CRD Engine Timing Tool Kit**

3Pc crankshaft and camshaft locking tool set for GM/Holden Colorado and Jeep/Chrysler 2.8D CRD engines. This allows the removal and replacement of the timing belt while maintaining the timed position.

**Was:\$107**

**NOW: \$84**



**No.6269SET VW/Audi/Skoda VAG 2.0 Camshaft Timing Tool Set**

This timing tool set is designed to suit VW/Audi/Skoda VAG 2.0 Litre Tdi PD DOHC and the ASZ and ASZI VAG engines.

**Was:\$142**

**NOW: \$114**



**No.A1784 Holden Colorado / Chrysler / Jeep 2.5L / 2.8L Diesel CRD Engine Timing Tool**

Timing tool set to help lock in the camshaft and crankshaft on the Holden Colorado and Trailblazer, Jeep Cherokee and Chrysler Grand Voyager.

**Was:\$293**

**NOW: \$234**



**No.QL-58B 3800Nm 1" Drive Torque Multiplier 58 to 1 Geared Wrench**

Sizes: 21mm Square x 1" Square Drive Impact Socket, 41mm Hexagon (6Pt.) x 1" Square Drive Impact Socket. Length: 310mm.  
Was:\$175  
**NOW: \$139**



**No.QL-88BS Two Speed 3000Nm 1" Drive Torque Multiplier 58 to 1 Geared Wrench**

Including two impact sockets: 21mm Sq. & 41mm Hexagon x 1" Square Drive Sockets. Weight: 6.5kg  
Was:\$240  
**NOW: \$192**



**No.6035 16" Detachable 4 Way Wheel Brace**

Suits the most popular 3 sizes: 17mm, 19mm, and 21mm plus a 1/2" Sq. Drive to suit any size socket.

Was:\$55  
**NOW: \$44**

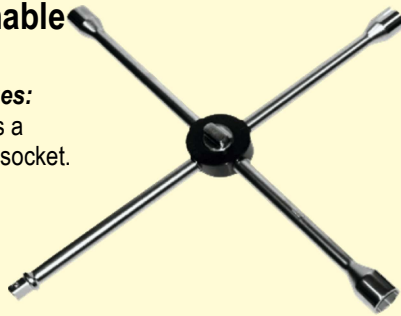

**No.5530 8 Piece Metric Ignition Wrench Set**

Include Sizes: 5mm, 5.5mm, 6mm, 7mm, 8mm, 9mm, 10mm, and 11mm supplied in vinyl pouch.  
Was:\$55  
**NOW: \$44**

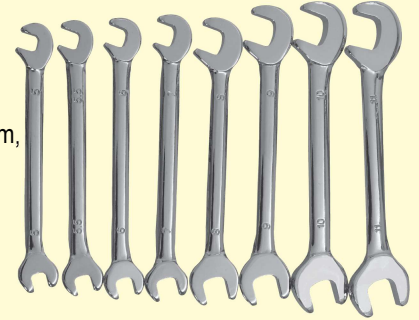

**No.7400 12.1/2" Chain Wrench**

Head design permits turning in either direction without removing wrench from the work. Handles all shapes, round, square, hexagon, octagon etc. Handles are forged from high grade alloy steel.  
Capacity: 1/2" to 4.3/4" (13 to 120mm).  
Handle Length: 12.1/2" (320mm). Chain Length: 20.1/4" (515mm).

Was:\$116  
**NOW: \$93**



**No.7408 8" Adjustable Chain Wrench**

Head design permits turning in either direction without removing wrench from the work.  
Capacity: 1/2" to 4.1/2" (13 to 115mm).  
Handle Length: 8" (200mm) Long x 3/8" (10mm) Diameter. Chain Length: 15.3/4" (400mm).  
Was:\$63  
**NOW: \$49**

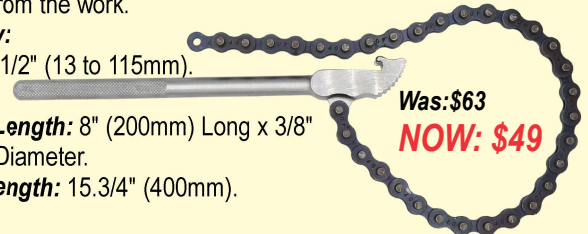

**No.32490 15" Adjustable Construction Wrench**

Jaw opening exceeds world-wide industrial standards and the special design of taper handle exclusively for construction.  
Capacity: 1.13/16" (46mm). Length: 15" (380mm).

Was:\$92  
**NOW: \$74**

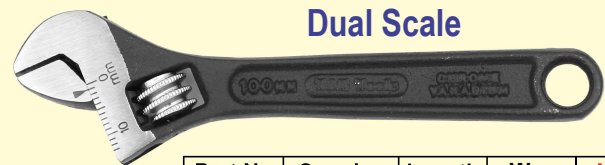
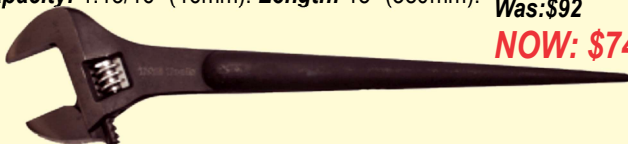

Dual Scale

**Adjustable Wrenches With Scales**

| Part No. | Opening | Length | Was   | NOW   |
|----------|---------|--------|-------|-------|
| 10004    | 13mm    | 100mm  | \$22  | \$18  |
| 10015    | 43mm    | 380mm  | \$91  | \$73  |
| 10018    | 53mm    | 270mm  | \$151 | \$119 |
| 10024    | 62mm    | 360mm  | \$379 | \$299 |

**No.13001 18 Piece SAE & Metric Combination Wrench Set**

SAE Sizes: 1/4", 5/16", 3/8", 7/16", 1/2", 9/16", 5/8", 11/16", 3/4".  
Metric Sizes: 8mm, 10mm, 11mm, 12mm, 13mm, 14mm, 15mm, 17mm, 19mm.  
Was:\$145  
**NOW: \$116**



**No.13999 12 Piece Metric Flex-Head Gearwrench**

Sizes: 8mm, 9mm, 10mm, 11mm, 12mm, 13mm, 14mm, 15mm, 16mm, 17mm, 18mm, 19mm.  
Was:\$388  
**NOW: \$309**

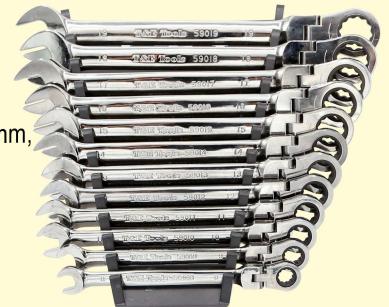

**No.13100L 10 Piece Metric Extra Long Combination Wrench Set**

Sizes: 10mm, 11mm, 12mm, 13mm, 14mm, 15mm, 16mm, 17mm, 18mm, 19mm.  
Was:\$157  
**NOW: \$126**



**No.13100A 12Pc. Metric Combination Wrench Set**

Sizes: 8mm, 9mm, 10mm, 11mm, 12mm, 13mm, 14mm, 15mm, 16mm, 17mm, 18mm and 19mm.  
Was:\$159  
**NOW: \$127**



**No.7043 2.3Lb. Dead-Blow Hammer**  
 Dead-blow action power with no bounce effect.  
 Safest non marring, non sparking hammer available.  
**Weight:** 1050g.  
**Length:** 13" (330mm).  
**Was:**\$66  
**NOW: \$53**



**No.1565 Straight Pein & Finishing Hammer**  
 39mm Slight Crown Face with 21mm cross pein end for working creases. Polished striking heads, and cheeks. High grade 1078 steel with American Hickory handle.  
**Head Weight:** 305g.  
**Length:** 13" (330mm).  
**Was:**\$53  
**NOW: \$42**



**No.EW4 4Pc. E-Series Torx-Flex-Head Gear Ratchet Wrench Set**  
 6 Point Gear Ratchet Wrench  
**Sizes:** E6 x E8, E10 x E12, E14 x E18, E20 x E24.  
**Was:**\$233  
**NOW: \$186**



**No.HPR6 6 Piece Metric Hi-Performance Long Ring Wrench Set**  
**Includes Sizes:**  
 10 x 11mm, 12 x 14mm, 13 x 15mm, 16 x 18mm, 17 x 19mm, 22 x 24mm.  
 Supplied in storage tray.  
**Was:**\$424  
**NOW: \$339**



**No.M5600 5 Piece SAE Half Moon Ring Set**  
**Sizes:** 5/16" x 3/8", 7/16" x 1/2", 9/16" x 5/8", 11/16" x 3/4", 3/4" x 7/8".  
**Was:**\$190  
**NOW: \$152**



**No.M5800 6 Piece Metric Half Moon Wrench Set**  
**Sizes:** 8 x 9mm, 10 x 11mm, 14 x 12mm, 13 x 15mm, 17 x 19mm, 16 x 18mm.  
**Was:**\$236  
**NOW: \$189**

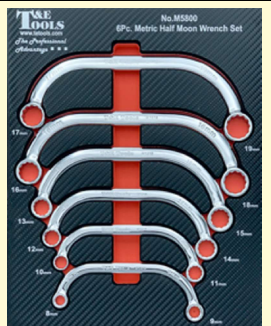

**No.S13107 7 Piece SAE Flex-Head Stubby Gear Wrench Set**  
**Sizes:** 3/8", 7/16", 1/2", 9/16", 5/8", 11/16", 3/4".  
**Was:**\$235  
**NOW: \$188**



**No.S13108 8 Piece Metric Flex-Head Stubby Gear Wrench Set**  
**Sizes:** 8mm, 10mm, 12mm, 13mm, 14mm, 15mm, 17mm, 19mm.  
**Was:**\$258  
**NOW: \$206**



**No.IS6001 5Pc. Metric VDE Insulated Open End Set**  
**Sizes:** 7mm, 8mm, 10mm, 12mm, 14mm.  
**Was:**\$80  
**NOW: \$64**



**No.750 Heavy Duty Locking Ring Set**  
 Designed for easy use on large circlips. Using a 3/8 ratchet to move the adjusting screw making it easier to use than ordinary pliers.  
**Was:**\$295  
**NOW: \$236**



**No.760 Gerridae Quick Connector Disconnect Tool**  
 Designed for hard to reach quick connect fittings where a button needs to be pressed to disengage.  
**Was:**\$74  
**NOW: \$59**



**Heavy Duty Pipe Wrench**  
 Full floating hook jaw, provides instant grip with easy release.

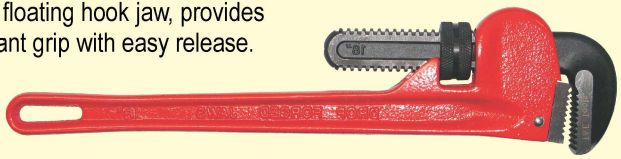

| Item No. | Length      | Max. Opening | Opening (mm) | Was   | Now  |
|----------|-------------|--------------|--------------|-------|------|
| AW1312   | 12" (300mm) | 2"           | 50mm         | \$59  | \$47 |
| AW1318   | 18" (450mm) | 2.1/2"       | 65mm         | \$101 | \$81 |

### Drive Socket Organizer



| Item No. | Length | Drive | Was  | Now         |
|----------|--------|-------|------|-------------|
| BA001    | 440mm  | 1/4"  | \$21 | <b>\$17</b> |
| BA002    | 440mm  | 3/8"  | \$21 | <b>\$17</b> |
| BA003    | 440mm  | 1/2"  | \$22 | <b>\$18</b> |

### Magnetic Glove / Tissue Dispenser

For storage of standard size boxes of latex gloves or tissues up to 145mm wide. Optional hanging holes for fixing in permanent locations

**Glove box not included.**



| Part No. | Colour | Was  | Now         |
|----------|--------|------|-------------|
| 5971     | Red    | \$27 | <b>\$22</b> |
| 5972     | Black  | \$27 | <b>\$22</b> |
| 5973     | Blue   | \$27 | <b>\$22</b> |

### Magnetic Can and Screwdriver Holder

Will hold 3 aerosol cans with a maximum diameter of 70mm. As well a holding aerosol cans there are slots at the front as well to hold either 7 Torx screwdrivers or 7 circular diameter items.

**Aerosols & screwdrivers not included.**



| Part No. | Colour | Was  | Now         |
|----------|--------|------|-------------|
| 5976     | Red    | \$30 | <b>\$24</b> |
| 5977     | Black  | \$30 | <b>\$24</b> |
| 5978     | Blue   | \$30 | <b>\$24</b> |

### Magnetic Paper Towel Holder

Holds most standard sized rolls of paper towels or shop towels. Can be used vertically or horizontally.

**Paper towel is not included.**



| Part No. | Colour | Was  | Now         |
|----------|--------|------|-------------|
| 5981     | Red    | \$20 | <b>\$16</b> |
| 5982     | Black  | \$20 | <b>\$16</b> |
| 5983     | Blue   | \$20 | <b>\$16</b> |

### 4Pc. Magnetic Parts Tray Set

Strong magnets hold on tools cabinet, industrial machinery housings or in the electronics industry. Rubber contacts to protect existing paintwork on metal surface. **Sizes:** 11 x 15cm, 11 x 21cm, 11 x 27cm & 11 x 31cm.



| Part No. | Colour | Was  | Now         |
|----------|--------|------|-------------|
| 5986     | Red    | \$65 | <b>\$52</b> |
| 5987     | Black  | \$65 | <b>\$52</b> |
| 5988     | Blue   | \$65 | <b>\$52</b> |

### No.7052 12oz. Ball Pein Hammer

Features a tough fibre glass handle with ribbed comfort grips & fully polished head.



Was: \$29 **NOW: \$23**

### No.8995 44" Heavy Duty Garage Creeper

**Material:** Powder-Coated Steel.

**Features:** Extra wide design and high density foam provides additional comfort.  
**Size:** 44"(1115mm)  
**Casters:** 3" x 6 pcs.  
**Capacity:** 180 Kg.



Was: \$181 **NOW: \$145**

### No.8997 Heavy Duty Mechanics Work Seat

**Feature:** Easy access storage tray, Chrome-plated finish and high density foam seat.

**Weight Capacity:** 180 Kg  
**Seat:** 245mm x 405mm (9.5/8" x 16")



Was: \$183  
**NOW: \$146**

### No.23688 3/8" Drive Speed Brace

Features special palm grip handle for pushing speed brace on fastener while rotating with other hand.

**Length:** 16.1/4" (410mm).



Was: \$57  
**NOW: \$46**

### No.24521 1/2" Drive 45 Tooth Pear Head Ratchet

**Quick Release**  
**Length:** 10" (255mm).

**New**



Was: \$77  
**NOW: \$59**

### No.CL105 35Pc. In-Hex & Torx-r Insert Bit Set

35 Piece In-Hex & Torx-r Insert Bit Set. Supplied in metal storage case.



Was: \$167  
**NOW: \$134**

### No.CL161 61Pc. Torx/Spline/Hex/S/Driver Bits & "E" Series Skts

61 Piece Torx, Spline, Hex, Slotted Driver Bits & "E" Series Socket Set. Supplied in metal storage case.



Was: \$259  
**NOW: \$207**

**No.4451 Diesel Compression Tester**

Test cylinder pressure on all diesel trucks and cars. Easy to read red & black dual scale gauge records pressure 0 to 1000psi (0 - 70bar). Swivel end coupler or easy connection of adaptors. Features pressure release valve at gauge.

**Gauge Readings:** 0 to 1000psi(0 to 70bar)  
**Gauge Diameter:** 2.1/2"(65mm)

**Was:**\$268

**NOW:** \$214

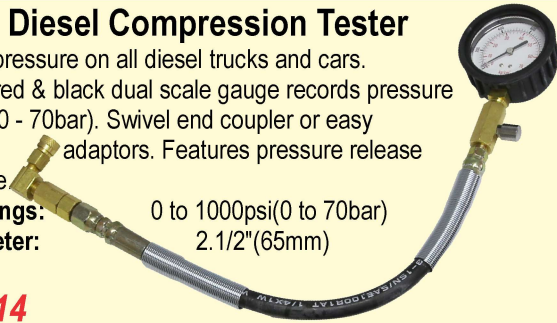

**No.CW404MS 5Pc. Deep Thin Wall Socket Set**

Special thin wall deep impact sockets are fitted with protective sleeves & inserts to prevent marking alloy wheels & to protect chrome wheel nuts.

**Sizes:** 15, 17, 19, 21 & 22mm

**Was:**\$125

**NOW:** \$99



**No.3292 Auto Fuse Current Leakage Detector**

Find the cause of flat batteries fast! Operates on 12Volt systems, and reads up to 20A. Displays the leakage current to rapidly identify the problem circuit. Checks for leakage on circuits. Easily replaces the fuses in the fusebox.

**Was:**\$107

**NOW:** \$86



**New**

**No.3395 Glow Plug Tester**

This tester is able to help diagnosing the condition of glow plug without removing it from the engine. This tester is working for 12V system.

**Was:**\$99

**NOW:** \$79

**New**



**No.3398 EFI Injector Tester**

Performs cylinder balance test on injectors for suspect performance. Power light and output light tell you when test is in activation. It fires individual injectors in 1/2 second increments. 1, 50 and 100 pulses for 5, 10 and 500 milliseconds.

**Was:**\$160 **NOW:** \$128

**New**



**No.3394 Oxygen Sensor Tester Lambda Tester & Simulator**

This device is designed to test & simulate 1V Zirconia and 1V/5V Titania type oxygen sensors. The simulation can help user to exam the function of the ECU.

**Was:**\$142

**NOW:** \$114



**New**

**No.3540 Circuit Relay Tester**

Technician is able to use the device to figure out the condition of the relay, and so speculating the problem in the vehicle. Use the relay adapter to plug into the relay tester, suitable to connection multiple styles relay.

**Was:**\$130

**NOW:** \$104

**New**



**No.3399 Ultrasonic Belt Tension Analyser**

A professional tool for measuring the tension on all belt drives, including auxiliary / camshaft belts. Features:

- Portable Probe
- 20 sets Frequency Storage
- Frequency Range: 10~600Hz

**Was:**\$204 **NOW:** \$163

**New**



**No.8999 35Kg Mobile Work Table**

Adjustable Height : 88 to 120cm  
Cushion Protection

Strong welded design can firmly support tools and other accessories. Fits under vehicles with a ground clearance greater than 130mm. 15 positions adjustable workbench, adapt to different working height. Four swivel ball-bearing casters, 2 casters with brake provide easy use. Table can folding 90° for space saving & convenient storage.

**Was:**\$245

**NOW:** \$196

**New**



**No.3324 12 Volt Battery Tester**

The tester will focus on health condition analysis of vehicle battery, it will estimate the cold cranking ampere (CCA) of the vehicle, and predict the lifetime of the battery.

**Was:**\$136

**NOW:** \$109

**New**



**No.J7058 Spicer / Rockwell / Meritor Universal Joint Service Tool Set**

Removes rusted and corroded bearings easily & mechanically, without damage to the U-Joint components. Fits practically all Class 7 and 8 trucks.

**Was:**\$429 **NOW:** \$329

